

KEY FEATURES

- Designed for compression drivers with 2" mouth diameter
- It provides uniform response, on and off-axis with a neutral and natural frequency reproduction
- Coverage angles of 60° in the horizontal plane and 40° in the vertical plane
- Straightforward mounting in compact enclosures thanks to its plane mouth finish and minimised horn depth



GENERAL DESCRIPTION

This 2" throat entry horn is constructed of cast aluminium, and is designed to provide uniform on and off-axis frequency response, with uncolored and natural sound reproduction. The constant directivity characteristics of this model ensure the ability to cover 60° wide horizontally and 40° wide vertically, at virtually any frequency within its operational range. Since the response remains essentially constant, equalisation is easily simplified. Its flat front finish facilitates flush mounting.

TECHNICAL SPECIFICATIONS

Throat diameter	49 mm. 2 in.
Horizontal beamwidth	60° (+34° -7°) (-6dB, 1.25 - 16 kHz)
Vertical beamwidth	40° (+28° -10°) (-6dB, 2 - 16 kHz)
Directivity factor (Q)	14.5 (average 1.25 -16 kHz)
Directivity index (DI)	11.6 dB (+1.5 dB, -3.7 dB)
Cutoff frequency	1 kHz
Dimensions	W x H x D: 191 x 246 x 118 mm.
Cutout dimensions	W x H: 150 x 215 mm.
Net weight	0.75 kg.
Shipping weight	0.85 kg.
Construction	Cast aluminium.
Connection of driver by four screws on a 4 in (101.6 mm.) diameter bolt circle.	

DIMENSION DRAWINGS

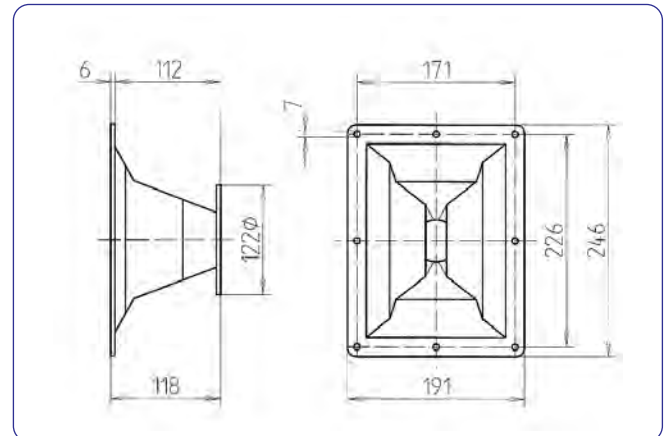

-6dB BEAMWIDTH*

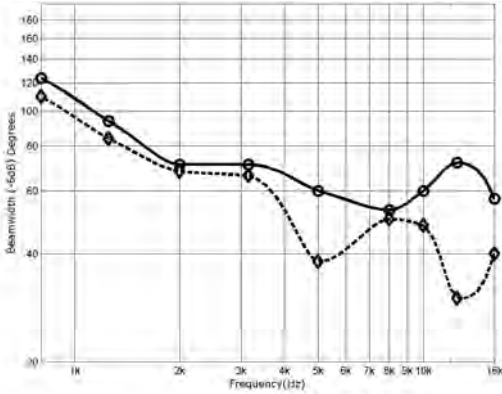

DIRECTIVITY

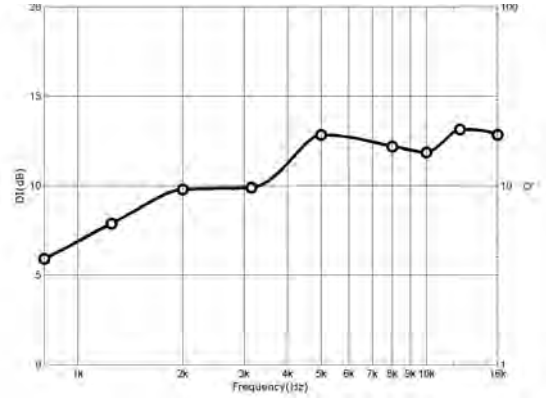

POLAR RESPONSE**

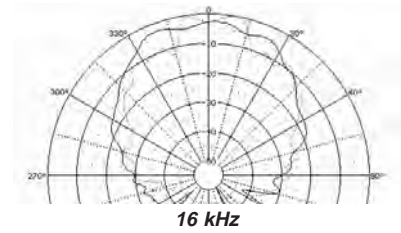
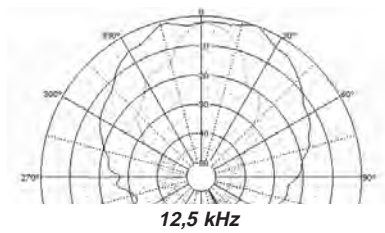
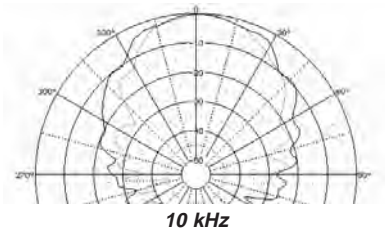
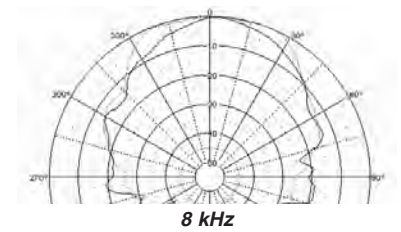
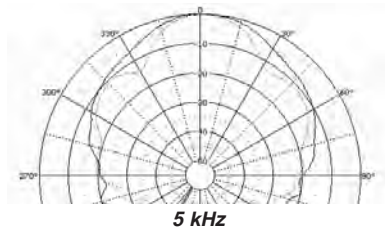
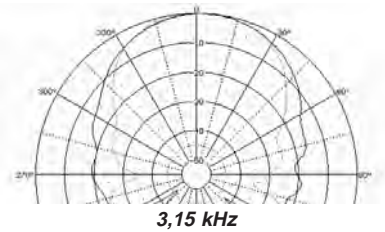
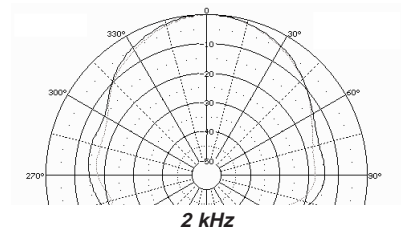
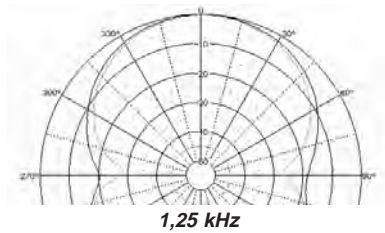
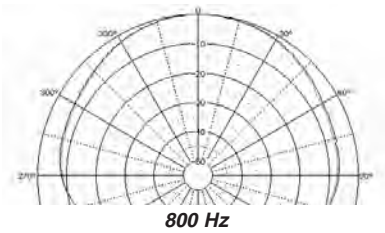

NOTES.
* Horizontal beamwidth is represented by the heavy line. Vertical beamwidth is represented by the discontinuous line.

** Horizontal response is represented by the heavy lines. Vertical response is represented by the discontinuous lines. The polar plots are reproduction of measurements done with single sinusoidal signal tones, at the indicated frequencies. The microphone was placed 2 m from the horn, and rotation was about the centre of the emitter source.



acústica beyma, s.a.